



Influence dosimetric study of different couches in radiotherapy treatments

Del Nero^a R.A., Emiliozzi^a C.Z.S., Siqueira^b P.T.D., Antunes^b P.C.G., Serante^a A.R.

^aHospital das Clínicas da Faculdade de Medicina da Universidade de São Paulo, 05403-000, São Paulo, Brasil

^bInstituto de Pesquisas Energéticas e Nucleares, 05508-000, São Paulo, Brasil

readelnero@gmail.com

ABSTRACT

Radiotherapy is a recommended procedure for 52% of cancer cases, in average, as one of the treatment forms, therefore, it is important for the clinical practice to investigate the affecting factors in dose distribution received by the patients, such as immobilization devices and treatment couch. With the introduction of treatments with modulated intensity techniques like IMRT and VMAT, the number of incidence fields used for patient treatment increased, making couch's dosimetric effect more significant in these modalities. The attenuation data acquisition referring to the treatment couches, as well as the TPS data evaluation, show important parameters for the clinical practice because they influence what happens with the dose delivery during the treatment, ensuring a better quality and safety to the treatments. This research presents experimental results evaluating the couch's impact in the treatments by a study of perturbation in the distribution of surface dose, and dose attenuation according to the gantry's angle for the couches BrainLABTM, ExactTM and iBEAMTM. Then we propose better density values for the couches BrainLABTM and ExactTM for their inclusion in EclipseTM TPS. Lastly, we compare the dose difference considering the presence or not of couch in the planning. In conclusion, the beam's attenuation increase by the couches and the doses alterations on the skin must be taken in consideration in the treatment planning process. It is of great relevance that each treatment center perform internal tests to determinate the best density values for available TPS.

Keywords: radiotherapy, attenuation, BrainLAB, Exact, iBEAM.



1. INTRODUCTION

Cancer, also known as neoplasm or malignant tumor, is the used term to define the rapid appearing of abnormal cells that grow beyond their limits. These cells can invade adjunct parts or spread to other organs [1]. It is estimated that radiotherapy is recommended, on average, for 52.3% of cancer cases as part of cancer treatment [2, 3]. This treatment alone is capable of providing up to 5 years of survival for 2.4% of all cancer patients [4]. The need for radiotherapy techniques optimization is evident with such relevant data about this oncological treatment.

The radiotherapy planning, however, may fail to consider dose calculation influencing factors. For example, planning often disregards the presence of the couch top, where the patient lies down during treatment. Due to this relevant detail, the American Association of Physicists in Medicine produced Task Group 176 (TG 176) [5], compiling more than 60 articles on the dosimetric effects caused by immobilization accessories and treatment couch tops, which can alter the dose distribution in the patient.

The outdated tennis racket-style treatment couches were supported on radio-opaque metal rails. Recent treatment couches, on the other hand, are made of a 2 to 4 mm thick carbon fiber shell filled with low density foam. Currently, there is a preference for these couches due to the combination of a semi-translucent radiological property with their high mechanical strength [6, 7]. Furthermore, due to their homogeneous construction, these carbon fiber couches present a noticeable improvement in image quality. This has become more relevant with the introduction of Intensity Modulated Radiotherapy (IMRT) and Volumetric Modulated Arc Therapy (VMAT) treatments, which the treatment beam can cross the couch during the dose delivery.

Surface dose is defined as the dose to an infinitesimal mass at the very surface of a phantom, and, according to TG 176 [5], there are several articles reporting a significant increase in surface dose when beams strike the carbon fiber couches at normal or oblique angles. In addition to the incidence angle, the surface dose and the build-up depend on other factors such as field size, energy and beam geometry [8]. Couches can also attenuate the beam on patient dose delivery, known as beam attenuation effect. The information gathered by TG 176 [5] points to an average dose attenuation

between 2 and 5%, and in some cases, up to 15%. Factors that can increase attenuation are beam energy, field size, and angle of incidence on the couch.

Treatment planning systems (TPS) do not usually include couches in the dose calculation as default, and the user is responsible for including it. Therefore, the objective of this work is to evaluate the dosimetric measures of attenuation for beams of 6 and 15 MV for BrainLAB™, Exact™ and iBEAM™ treatment couches, in order to analyze the data used by the TPS dose calculation algorithms. Another objective is to evaluate the couch model included in its library to improve the dose calculation in radiotherapy patients.

2. MATERIALS AND METHODS

Measurements with the BrainLAB Imaging Couch Top™, Brainlab AG (Munich, Germany), were performed on a Varian Medical System 6EX™ linear accelerator (Palo Alto, United States), capable of generating a 6 MV radiation beam energy, dose rate of 600 UM/min, equipped with a BrainLAB m3™ multileaf collimator, which consists of multiple 3 mm, 4.5 mm and 5.5 mm thick leafs. The couch properties are 530 mm X 2,000 mm X 50 mm, 2 mm thick carbon fiber shell and foam padding [10].

The experiments with the Exact IGRT Couch™ were performed on a Varian Medical System 2100C™ linear accelerator, capable of generating 6 and 15 MV radiation beam energies, dose rate of 600 UM/min, equipped with a multileaf collimator Millennium MLC-120, which consists of 5 mm leafs in the central region and 10 mm leafs at the edges. This couch dimensions are 530 mm wide, 2,000 mm long and its thickness varies along its longitudinal length, with 50 mm in the thinnest portion corresponding to the head and neck accommodation (defined in the TPS as thin), and 75 mm thick in the thickest portion corresponding to the abdomen and pelvis accommodation region (defined in the TPS as thick). This nomenclature is valid for positioning the head towards the gantry. In the thin portion there is 0.85mm of carbon fiber on the above surface of the couch and 1.05 mm on the underneath surface. In the thick portion, there is 1.25 mm of carbon fiber on the above surface and 3.05 mm underneath [11].

Measurements with the iBEAM evo CouchtopTM were performed in Elekta AxesseTM linear accelerator (Stockholm, Sweden), capable of generating 6 and 15 MV radiation beam energies, dose rate of 600 UM/min, equipped with a Beam Modulator multileaf collimator, which consists of 40 pairs of 4 mm thick leaves. The couch dimensions are 530 mm x 2,000 mm x 51.5 mm. Its structure is formed by a 1.2 mm thick carbon fiber shell and filled with 47.6 mm thick foam [12].

2.1. Surface dose and build-up

The measurements were divided into two parts:

1. Build-up measurements with and without the influence of the couch: gantry positioned at 0°, five solid water slabs of 1 cm thick were placed on the couch. The insert slab with the PTW MarkusTM ionization chamber (Freiburg, Germany) was placed on top of this stack, with a source-surface distance (SSD) of 100 cm (Figure 1). PTW Unidos ETM electrometer was used. After the initial measurement, keeping the same SSD, more solid water slabs were added over the chamber until the build-up depth was achieved. One hundred monitor units (MU) were used in each measurement and a dose rate of 600 MU/min. This same configuration was used for the 4x4, 6x6, 10x10 and 20x20 cm² fields. For the couch influence measurements, the gantry was positioned at 180° and the solid water slabs stack configuration was inverted (Figure 2).

2. Surface dose measurements with and without the influence of the couch: gantry positioned at 180° and the solid water slabs configuration was inverted. It means that the insert slab was in contact with the couch, and over it 5 cm of solid water slabs, the SSD was kept at 100 cm on the couch surface. Then, other solid water slabs were added between the chamber and the couch, keeping the 100 cm SSD on the couch surface (Figure 2). For measurements without the influence of the couch, the configuration shown in Figure 1 was used.

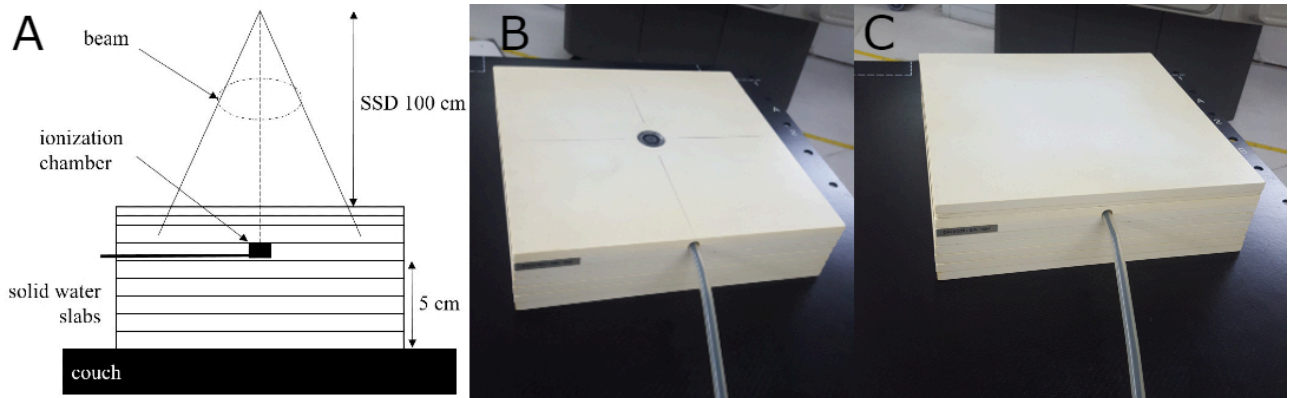

Figure 1: A) Experiment setup for build-up and surface dose measurements with gantry 0° , SSD 100 cm; B) Ionization chamber insertion slab positioned above another 5 solid water slabs on the BrainLAB™ couch; C) Addition of solid water slabs over the ionization chamber insertion slab on the same couch.

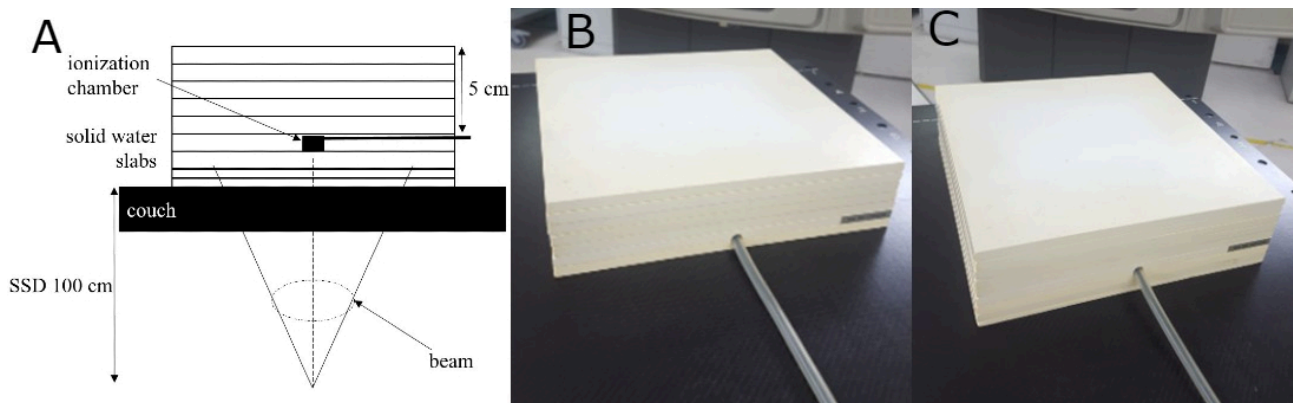

Figure 2: A) Experiment setup for surface dose measurements and build-up with gantry 180° , SSD 100 cm; B) Ionization chamber insertion slab in contact with the couch, with the reading face positioned down, with 5 solid water slabs above it; C) Addition of solid water slabs between the BrainLAB™ couch and the ionization chamber insertion slab.

After obtaining measurements, the build-up depth found was corrected by 1 mm due ionization chamber's effective measurement point [13], and also by a factor used to convert the depth from solid water to water (multiply by the density of solid water 1.045 g/cm^3 [14]).

2.2. Dose attenuation

For the attenuation measurements, a 16 cm diameter acrylic cylindrical phantom (Figure 3), we used a PTW PinPoint TN31016™ ionization chamber and a PTW Unidos E™ electrometer. The

phantom was positioned on the treatment couch and aligned by the lasers in the linear accelerator room. Then, the ionization chamber was inserted into the phantom, positioning the sensitive volume at the isocenter. The first measurement was performed with the gantry at 0° and the result was used as a reference value (zero attenuation). Subsequently, measurements were repeated with 20° increments between angles from 0° to 80°. Between 90° and 270°, with oblique beams posterior to the couch, measurements were made in 10° increments (Figure 4). 400 MU were used in each measurement and a dose rate of 600 MU/min. This configuration was used for the 5x5 and 10x10 cm² field sizes for the BrainLABTM and ExactTM couches. For the iBEAMTM couch, the field sizes of 4x4 and 10.4x10.4 cm² were used.

To measure the linear accelerator variation output according to the gantry angle, gantry angle dependence measurements were made in the same angles of attenuation measurements, using IBA Farmer FC65-PTM ionization chamber (Louvain-la-Neuve, Belgium), IBA Dose 1TM electrometer, build-up caps of 3 and 5 cm diameter for 6 and 15 MV energies, respectively. The beam attenuation was calculated by equation 1 [7] due to the presence of the couch for each beam angle of incidence. L_{ref} is the reference value of the gantry readings at 0° and L_{couch} is the gantry reading at the measurement angles. The gantry angle dependence measurements at the same angles as the beam attenuation measurements were also normalized according to equation 1. Finally, the values of the gantry angle dependence measurements were subtracted from the attenuation measurements.

$$Attenuation = \left(1 - \left(\frac{L_{couch}}{L_{ref}} \right) \right) \times 100 \quad (1)$$

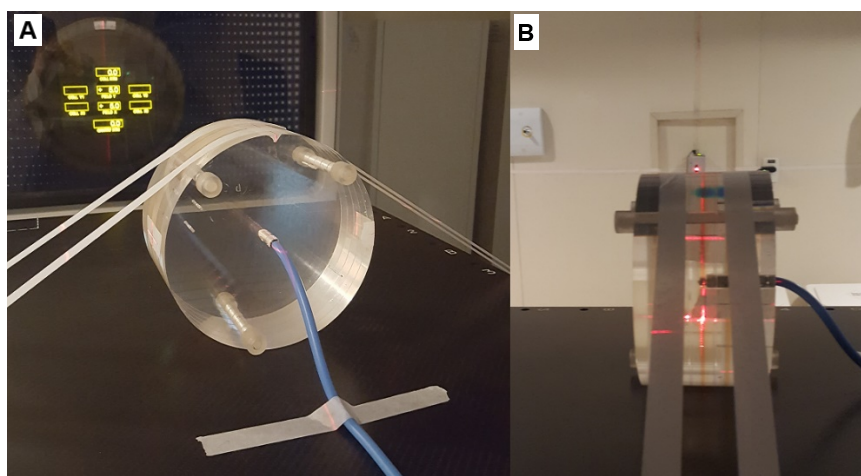

Figure 3: Phantom and ionization chamber positioning at the accelerator isocenter; A) Front view; B) Side view.

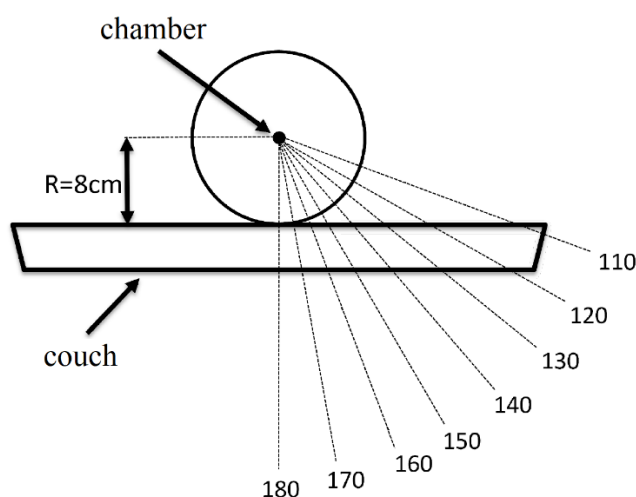

Figure 4: Illustration demonstrating intersection lengths of beams emitted posterior to the couch according to the angle of the gantry in relation to the isocenter.
Source: Serante et al. [15].

2.3. Couch inclusion in TPS

The cylindrical phantom computed tomography (CT) scans were transferred into the TPS Eclipse™ (Varian Medical Systems version 13.6, Anisotropic Analytical Algorithm - AAA version 13.6.23 and 0.25 cm calculation grid). The same angles used in the dose attenuation measurements (heading 2.2) were simulated in TPS. In addition, the ionization chamber sensitive volume was delineated in the TPS according to its real dimensions.

TPS Eclipse™ interprets the structures density in Hounsfield units (HU), and has a library of treatment couches delineated as structures for inclusion in patient CT scans. This library also includes the default material density values of the structures for different couches. The default values for the BrainLAB™ couch are -200 HU (0.82 g/cm³) for carbon fiber and -900 HU (0.08 g/cm³) for foam, and for the Exact® couch, -300 HU (0.71 g/cm³) and -1,000 HU (0.001 g/cm³), respectively.

To evaluate the attenuation profile due to the treatment couches in the TPS, the BrainLAB™ couch carbon fiber shell and the inner foam density values were varied from 1.2 to 0.55 g/cm³ and 0.1 to 0.03 g/cm³, respectively. For the Exact™ couch, the carbon fiber shell and the inner foam densities were varied, respectively, from 1.2 to 0.55 g/cm³ and 0.1 to 0.001 g/cm³. This range of density variations is based on previously published works [12–14].

The data combination results in the TPS (angle x carbon fiber density x foam density x field size) generated the data that were compared with the experimental measurements obtained in heading 2.2. The process's aims to find combinations of density values in HU that generate an attenuation in the TPS closer to the experimental measurements.

After obtaining the best densities combination to be used in TPS, VMAT and IMRT pelvis planning with 5x700 cGy fractionation in anthropomorphic phantom were compared, with and without the presence of BrainLAB™ and Exact™ treatment couches in order to assess the dosimetric impact on dose calculation when the couch is not included in treatment planning.

3. RESULTS

3.1. Surface dose and build-up

The BrainLAB™ couch build-up and surface dose measurements results are in Table 1. All measurements were performed at 6 MV energy. With the gantry at 0°, the maximum dose depth for the 4x4, 6x6 and 10x10 cm² fields was found to be 1.4 cm. For the 20x20 cm² field, the depth found was 1.3 cm. With the gantry at 180°, the maximum dose depth for the 4x4 and 10x10 cm² fields is 0.3 cm, for the 6x6 cm² field is 0.4 cm, and for the 20x20 cm² field is 0.2 cm. Subtracting the mean maximum dose depth with the gantry at 180° (0.3 cm) from the mean depth value with the gantry at

0° (1.4 cm), we obtain that the BrainLab™ couch equals to 1.1 cm of water for a 180° gantry incidence.

Regarding the surface dose measurements (0.1 cm depth), we have that the average dose normalized by the maximum dose is 49.50% with the gantry at 0° for the 4x4, 6x6, 10x10 and 20x20 cm² fields. With the gantry at 180°, the average dose is 98.86% for the same field sizes. The difference between these averages is 49.36%. This is the approximate percentage increase in the dose deposited on the skin in contact with the couch.

Table 1: Maximum dose depth in centimeters (build-up) and normalized surface dose results for 0° and 180° angles, BrainLAB™ couch, 6 MV.

	6 MV				
	Angle (°)	4x4 cm ²	6x6 cm ²	10x10 cm ²	20x20 cm ²
Build-up (cm)	0	1.4	1.4	1.4	1.3
	180	0.3	0.4	0.3	0.2
Surface dose	0	44.55%	46.20%	49.54%	57.72%
	180	98.32%	98.88%	99.06%	99.18%

The build-up and surface dose results for the Exact™ couch are in Table 2. Measurements were performed for 6 and 15 MV energies. With the gantry at 0° and 6 MV energy, the maximum dose depth for the 4x4 cm² field is 1.6 cm and for the 6x6, 10x10 and 20x20 cm² fields is 1.5 cm. With the gantry at 0° and energy of 15 MV, the maximum dose depth for the 4x4, 6x6 and 10x10 cm² fields is 2.7 cm and for the 20x20 cm² field is 1.7 cm.

With the gantry at 180° and 6 MV energy at the thinnest part of the couch, the maximum dose depth for the 4x4 cm² field is 0.9 cm, for the 6x6 and 20x20 cm² fields is 0.7 cm, and for the 10x10 cm² field is 0.8 cm. From this data, Exact™ couch is equivalent to 0.7 cm of water in the thinnest portion. Following the same reasoning, for 6 MV, the thickest portion is equivalent to 0.8 cm of water. According to the data in Table 2, at the 15 MV energy, the thin and thick regions are equivalent, respectively, to 0.15 and 0.23 cm of water.

On the surface dose measurements of the Exact™ couch, the mean dose normalized by the maximum dose with the gantry at 0° is 49.37% for the 6 MV energy and 32.03% for the 15 MV energy. In the thinnest portion of the couch, with the gantry at 180°, the average dose is 89.14% for

6 MV energy and 70.74% for 15 MV energy. The difference between these averages is 39.77% for 6 MV and 38.71% for 15 MV. These are the approximate percentage increases of the dose deposited on the skin in the thinnest region of the couch. Following the same reasoning, the percentage increases in dose deposited on the skin in the thickest region of the couch are 43.35% and 45.03% at 6 and 15 MV energies, respectively.

Table 2: Maximum dose depth in centimeters (build-up) and normalized surface dose results for 0° and 180° angles, thin and thick Exact™ couch regions, 6 and 15 MV.

		6 MV					15 MV			
		Angle (°)	4x4 cm ²	6x6 cm ²	10x10 cm ²	20x20 cm ²	4x4 cm ²	6x6 cm ²	10x10 cm ²	20x20 cm ²
Build-up (cm)		0	1.6	1.5	1.5	1.5	2.7	2.7	2.7	1.7
	thin	180	0.9	0.7	0.8	0.7	2.6	2.4	2.2	2.0
	thick	180	1.1	0.7	0.7	0.4	2.5	2.4	2.2	1.8
Surface dose		0	44.06%	45.69%	49.43%	58.31%	24.41%	26.88%	32.33%	44.49%
	thin	180	84.83%	88.06%	90.54%	93.14%	62.88%	66.93%	72.33%	80.82%
	thick	180	88.29%	91.67%	94.38%	96.56%	68.19%	73.53%	79.56%	86.94%

Table 3 shows the build-up and surface dose results for the iBEAM™ couch at 6 and 15 MV energies. With the gantry at 0° and 6 MV energy, the maximum dose depth for the 4x4 and 10.4x10.4 cm² fields is 1.7 cm. With the gantry still at 0° and 15 MV energy, the maximum dose depth for the 4x4 cm² field is 2.9 cm and for the 10.4x10.4 cm² field is 2.7 cm. With the gantry at 180° and 6 MV energy, the maximum dose depth for the 4x4 cm² field is 1.1 cm and for the 10.4x10.4 cm² field is 0.8 cm. At this same angle and energy of 15 MV, the maximum dose depth for both fields is 2.2 cm. Subtracting the mean maximum dose depth with the gantry at 180° (0.95 cm) from the mean depth value with the gantry at 0° (1.7 cm), we obtain that the iBEAM™ couch is equivalent to 0.75 cm of water for a 180° gantry incidence and 6 MV energy. Following the same procedures, this couch is equivalent to 0.6 cm of water for 15 MV energy.

Regarding the surface dose measurements, we obtain that the average dose normalized by the maximum dose is 42.14% and 88.98% with the gantry at 0° and 180°, respectively, for the 6 MV energy, and for the 15 MV energy, 27.39% and 71.08%. The difference between these averages is

46.84% and 43.69% for 6 and 15 MV energies, respectively. These are approximate percentage increases in dose delivered to the skin in contact with the iBEAMTM couch.

Table 3: Maximum dose depth in centimeters (build-up) and surface dose normalized results for angles 0° and 180°, iBEAMTM couch, 6 and 15 MV.

	Angle (°)	6 MV		15 MV	
		4x4 cm ²	10.4x10.4 cm ²	4x4 cm ²	10.4x10.4 cm ²
Build-up (cm)	0	1.7	1.7	2.9	2.7
	180	1.1	0.8	2.2	2.2
Surface dose	0	39.21%	45.07%	23.00%	31.78%
	180	85.85%	92.12%	65.91%	76.26%

3.2. Dose attenuation

The BrainLABTM couch attenuation results are compiled in Figure 5. In the gantry angular range between 0° to 100° and between 260° to 360° there is no attenuation for the measured fields, since the beams do not cross the couch. However, between 110° to 250° angular range, the beam hits the couch and dose attenuation occurs. The attenuation is the greatest for the angles 120° (8.03%) and 240° (8.33%) for the field size 5x5 cm², and for the field size 10x10 cm² the attenuation is also the highest at 120° (7.67%) and 250° (7.82%). On average, it is also observed that the field size 5x5 cm² has a greater attenuation caused by the couch in relation to the field size 10x10 cm². The average uncertainty generated by the variation of the linear accelerator output in relation to the gantry angle for the 5x5 and 10x10 cm² field sizes is, respectively, 0.19% and 0.23%.

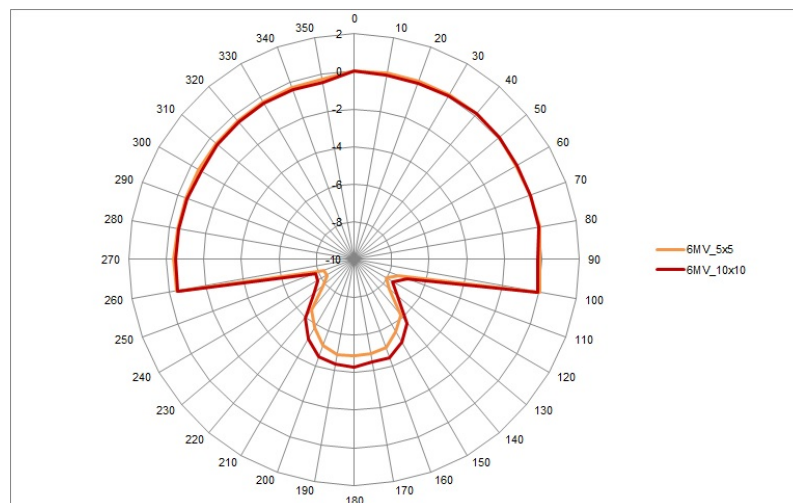

Figure 5: Attenuation measurements for BrainLAB™ couch due to beam incidence angle, 6 MV.

All attenuation radial graphs were plotted from modified equation 1 (multiplied by -1) for better visual representation of the attenuation effect. For the Exact™ couch, the attenuation results are compiled in Figure 6. There is no dose attenuation between the angular range of 0° to 100° and 260° to 360°, but the data indicate a fluctuation due to the uncertainty of the measurements.

In the thinnest portion of the couch (Figure 6A), two field sizes were measured, 5x5 and 10x10 cm². For the 5x5 cm² field and 6 MV energy, the attenuation is the greatest for the angles 110° (5.0%) and 240° (4.12%). For the 10x10 cm² field still at 6 MV energy, the attenuation is the highest at the angles 110° (4.51%) and 250° (3.81%). For 15 MV energy, in the 5x5 cm² field, the greatest attenuation occurs at 110° (3.52%) and also at 250° (2.74%). In the 10x10 cm² field, the greatest attenuation is found at 110° (2.95%) and 240° (2.18%).

In the thickest portion of the couch (Figure 6B), two field sizes were also measured, 5x5 and 10x10 cm². For the 5x5 cm² field and 6 MV energy, the attenuation is the greatest for the angles 110° (6.03%) and 250° (5.27%). For the 10x10 cm² field still at 6 MV energy, the attenuation is the highest at the angles 110° (5.68%) and 250° (5.05%). For the energy of 15 MV, in the 5x5 cm² field, the greatest attenuation occurs at 110° (4.25%) and also at 250° (3.47%). In the 10x10 cm² field, the greatest attenuation is found at 110° (3.97%) and 250° (3.05%).

The average uncertainty generated by the linear accelerator variation output in relation to the gantry angle for the 5x5 and 10x10 cm² field sizes is, respectively, 0.32% and 0.53% for 6 MV energy.

For 15 MV energy, the uncertainty for field sizes 5x5 and 10x10 cm² is 0.14% and 0.05%, respectively.

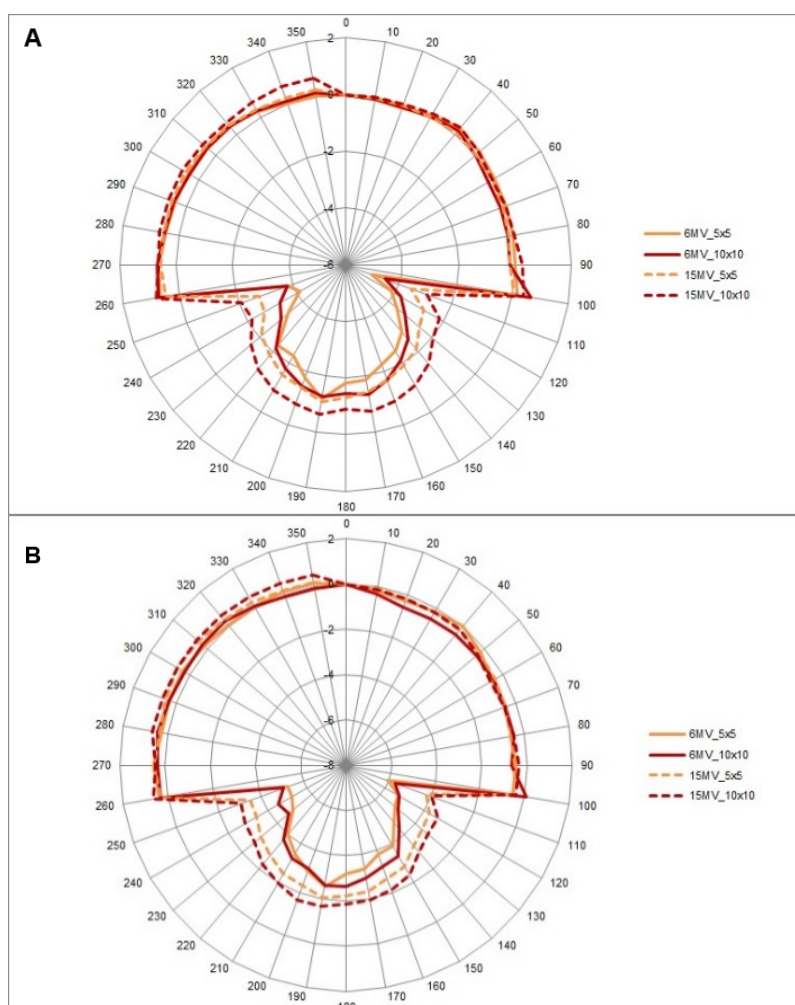

Figure 6: Attenuation measurements for the ExactTM couch due to beam incidence angle, 6 and 15 MV; A) Thinner portion; B) Thicker portion.

For the iBEAMTM couch, the attenuation results are compiled in Figure 7. For the 4x4 cm² field and 6 MV energy, the attenuation is highest for the angles 120° (4.8%) and 240° (4.77 %). For the 10.4x10.4 cm² field still at 6 MV, the attenuation is also highest at the angles 120° (4.63%) and 240° (4.65%). For 15 MV energy and in the 4x4 cm² field, the greatest attenuation occurs at 120° (3.6%) and at 240° (3.26%). In the 10.4x10.4 cm² field, the greatest attenuation occurs at 120° (3.42%) and 250° (3.22%). The average uncertainty generated by the variation of the linear accelerator output in

relation to the gantry angle for the 4x4 and 10.4x10.4 cm² field sizes for the iBEAMTM couch are, respectively, 0.15% and 0.24% for 6 MV energy. For 15 MV energy, the uncertainty for the 4x4 and 10.4x10.4 cm² field sizes are 0.29% and 0.52%, respectively.

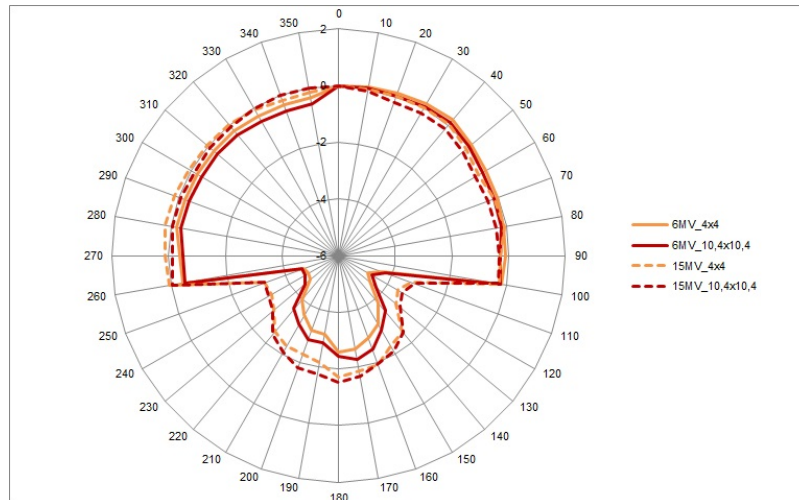

Figure 7: Attenuation measurements for the iBEAMTM couch due to beam incidence angle, 6 and 15 MV.

3.3. Couch inclusion in TPS

The doses obtained from the couch density combinations in the TPS were compared with data obtained from the attenuation experimental readings. For the BrainLABTM couch readings, each carbon fiber shell density value of 1.2 g/cm³ (HU = 299), 0.82 g/cm³ (HU = -200), 0.7 g/cm³ (HU = -309) and 0.55 g/cm³ (HU = -437) were compared with three different density values of the foam couch padding of 0.1 g/cm³ (HU = -877), 0.08 g/cm³ (HU = -900) and 0.03 g/cm³ (HU = -947). However, only the best combination of densities are shown in Table 4. In other words, the smallest attenuation mean difference (experimental readings subtracted from TPS) and also the couch's default values. The best densities combination observed were 1.2 g/cm³ (HU = 299) for carbon fiber and 0.1 g/cm³ (HU = -877) for foam padding.

Table 4: Different carbon fiber and foam padding combinations for BrainLAB™ couch, 6 MV.

Angle (°)	5x5 cm ²				10x10 cm ²					
	Best combination		Default values		Best combination		Default values			
	Carbon fiber 1.2 g/cm ³ (HU = 299)	Foam 0.1 g/cm ³ (HU = -877)	Carbon fiber 0.82 g/cm ³ (HU = -200)	Foam 0.08 g/cm ³ (HU = -900)	Carbon fiber 1.2 g/cm ³ (HU = 299)	Foam 0.1 g/cm ³ (HU = -877)	Carbon fiber 0.82 g/cm ³ (HU = -200)	Foam 0.08 g/cm ³ (HU = -900)		
Experimental (%)	TPS (%)	TPS - Experimental (%)	TPS (%)	TPS - Experimental (%)	Experimental (%)	TPS (%)	TPS - Experimental (%)	TPS (%)	TPS - Experimental (%)	
0	0.00	0.00	0.00	0.00	0.00	0.00	0.00	0.00	0.00	
110	-7.48	-7.63	-0.15	-5.07	2.40	-7.03	-6.42	0.61	-4.19	2.84
120	-8.03	-9.09	-1.06	-6.67	1.36	-7.67	-7.65	0.01	-5.57	2.09
130	-7.52	-8.23	-0.70	-5.80	1.72	-6.97	-6.84	0.14	-4.73	2.25
140	-6.17	-6.90	-0.73	-4.88	1.29	-5.59	-5.75	-0.16	-4.04	1.56
150	-5.56	-6.00	-0.44	-4.28	1.28	-4.92	-5.03	-0.11	-3.43	1.48
160	-5.05	-5.64	-0.59	-3.95	1.11	-4.45	-4.64	-0.19	-3.34	1.10
170	-4.91	-5.34	-0.43	-3.65	1.26	-4.49	-4.46	0.03	-3.07	1.42
180	-4.89	-5.01	-0.12	-3.52	1.37	-4.28	-4.19	0.09	-2.92	1.36
	Mean difference (%)		-0.53		1.47			0.05		1.76

About the Exact™ couch, each carbon fiber shell density value of 1.2 g/cm³ (HU = 299), 0.82 g/cm³ (HU = -200), 0.71 g/cm³ (HU = -300) and 0.55 g/cm³ (HU = -437) were tested with four different couch foam padding density values of 0.1 g/cm³ (HU = -877), 0.08 g/cm³ (HU = -900), 0.03 g/cm³ (HU = -947) and 0.001 g/cm³ (HU = -1000). For convenience, we show in Tables 5 and 6 only the best densities combinations, and default values for 6 and 15 MV energies for different couch thicknesses region. The best densities combination found for the thinnest couch portion was 0.82 g/cm³ (HU = -200) for the carbon fiber, and 0.001 g/cm³ (HU = -1,000) for the foam padding. For the thicker portion, 0.82 g/cm³ (HU = -200) and 0.03 g/cm³ (HU = -947), respectively.

Table 5: Different carbon fiber and foam padding combinations for Exact™ couch thin region;
A) 6 MV; B) 15 MV.

A	Best combination				Default values		Best combination				Default values	
	Carbon fiber 0.82 g/cm ³ (HU = -200) Foam 0.001 g/cm ³ (HU = -1,000)				Carbon fiber 0.71 g/cm ³ (HU = -300) Foam 0.001 g/cm ³ (HU = -1,000)		Carbon fiber 0.82 g/cm ³ (HU = -200) Foam 0.001 g/cm ³ (HU = -1,000)				Carbon fiber 0.71 g/cm ³ (HU = -300) Foam 0.001 g/cm ³ (HU = -1,000)	
5x5 cm ²						10 x 10 cm ²						
Angle (°)	Experimental (%)	TPS (%)	TPS - Experimental (%)	TPS (%)	TPS - Experimental (%)	Experimental (%)	TPS (%)	TPS - Experimental (%)	TPS (%)	TPS - Experimental (%)		
0	0.00	0.00	0.00	0.00	0.00	0.00	0.00	0.00	0.00	0.00		
110	-5.00	-4.71	0.29	-4.02	0.99	-4.51	-3.92	0.59	-3.29	1.22		
120	-4.14	-4.38	-0.24	-3.76	0.39	-3.74	-3.62	0.12	-3.08	0.65		
130	-3.65	-3.49	0.16	-3.06	0.59	-3.26	-2.72	0.54	-2.36	0.90		
140	-2.92	-2.70	0.22	-2.37	0.55	-2.55	-2.15	0.40	-1.89	0.67		
150	-2.51	-2.54	-0.03	-2.24	0.26	-2.11	-2.03	0.08	-1.77	0.35		
160	-2.25	-2.44	-0.19	-2.11	0.14	-1.67	-1.89	-0.21	-1.59	0.09		
170	-1.88	-2.24	-0.36	-2.01	-0.13	-1.36	-1.89	-0.53	-1.59	-0.23		
180	-1.80	-2.11	-0.30	-1.71	0.09	-1.46	-1.74	-0.28	-1.41	0.05		
Mean difference (%)			-0.06	0.36			0.09			0.46		

B	Best combination				Default values		Best combination				Default values	
	Carbon fiber 0.82 g/cm ³ (HU = -200) Foam 0.001 g/cm ³ (HU = -1,000)				Carbon fiber 0.71 g/cm ³ (HU = -300) Foam 0.001 g/cm ³ (HU = -1,000)		Carbon fiber 0.82 g/cm ³ (HU = -200) Foam 0.001 g/cm ³ (HU = -1,000)				Carbon fiber 0.71 g/cm ³ (HU = -300) Foam 0.001 g/cm ³ (HU = -1,000)	
5x5 cm ²						10 x 10 cm ²						
Angle (°)	Experimental (%)	TPS (%)	TPS - Experimental (%)	TPS (%)	TPS - Experimental (%)	Experimental (%)	TPS (%)	TPS - Experimental (%)	TPS (%)	TPS - Experimental (%)		
0	0.00	0.00	0.00	0.00	0.00	0.00	0.00	0.00	0.00	0.00		
110	-3.52	-3.27	0.25	-2.79	0.73	-2.95	-2.80	0.15	-2.36	0.59		
120	-2.79	-2.99	-0.19	-2.57	0.23	-2.18	-2.54	-0.36	-2.18	0.00		
130	-2.60	-2.40	0.20	-2.09	0.50	-1.97	-1.97	0.01	-1.68	0.30		
140	-2.11	-1.87	0.24	-1.62	0.49	-1.45	-1.55	-0.10	-1.31	0.14		
150	-1.88	-1.73	0.15	-1.51	0.38	-1.11	-1.44	-0.34	-1.23	-0.13		
160	-1.66	-1.65	0.02	-1.42	0.24	-0.89	-1.34	-0.45	-1.15	-0.27		
170	-1.45	-1.54	-0.08	-1.34	0.11	-0.76	-1.31	-0.55	-1.10	-0.34		
180	-1.29	-1.42	-0.13	-1.14	0.15	-0.91	-1.21	-0.30	-0.94	-0.03		
Mean difference (%)			0.06	0.35			-0.24			0.03		

Table 6: Different carbon fiber and foam padding combinations for Exact™ couch thick region; A) 6 MV; B) 15 MV.

A												
		Best combination				Default values						
		Carbon fiber 0.82 g/cm ³ (HU = -200)		Foam 0.03 g/cm ³ (HU = -947)		Carbon fiber 0.71 g/cm ³ (HU = -300)		Foam 0.001 g/cm ³ (HU = -1,000)		Carbon fiber 0.82 g/cm ³ (HU = -200)		
										Carbon fiber 0.71 g/cm ³ (HU = -300)		
										Foam 0.03 g/cm ³ (HU = -947)		
		5x5 cm²				10x10 cm²						
Angle (°)	Experimental (%)	TPS (%)	TPS - Experimental (%)	TPS (%)	TPS - Experimental (%)	Experimental (%)	TPS (%)	TPS - Experimental (%)	TPS (%)	TPS - Experimental (%)	TPS (%)	TPS - Experimental (%)
0	0.00	0.00	0.00	0.00	0.00	0.00	0.00	0.00	0.00	0.00	0.00	0.00
110	-6.03	-5.53	0.49	-4.02	2.01	-5.68	-4.55	1.13	-3.29	2.39		
120	-5.34	-5.73	-0.39	-3.23	2.11	-5.30	-4.73	0.57	-2.63	2.66		
130	-5.19	-5.47	-0.27	-2.83	2.36	-4.98	-4.43	0.55	-2.15	2.83		
140	-4.72	-4.68	0.04	-2.44	2.28	-4.35	-3.77	0.58	-1.92	2.43		
150	-3.88	-4.28	-0.41	-2.24	1.64	-3.36	-3.47	-0.11	-1.80	1.57		
160	-3.79	-3.89	-0.09	-2.04	1.75	-3.24	-3.17	0.07	-1.62	1.62		
170	-3.34	-3.75	-0.42	-2.04	1.30	-2.92	-3.05	-0.13	-1.68	1.25		
180	-3.18	-3.43	-0.25	-1.78	1.40	-2.63	-2.81	-0.18	-1.44	1.19		
Mean difference (%)			-0.16		1.86			0.31		1.99		
B												
		Best combination				Default values						
		Carbon fiber 0.82 g/cm ³ (HU = -200)		Foam 0.03 g/cm ³ (HU = -947)		Carbon fiber 0.71 g/cm ³ (HU = -300)		Foam 0.001 g/cm ³ (HU = -1,000)		Carbon fiber 0.82 g/cm ³ (HU = -200)		
										Carbon fiber 0.71 g/cm ³ (HU = -300)		
										Foam 0.03 g/cm ³ (HU = -947)		
		5x5 cm²				10x10 cm²						
Angle (°)	Experimental (%)	TPS (%)	TPS - Experimental (%)	TPS (%)	TPS - Experimental (%)	Experimental (%)	TPS (%)	TPS - Experimental (%)	TPS (%)	TPS - Experimental (%)	TPS (%)	TPS - Experimental (%)
0	0.00	0.00	0.00	0.00	0.00	0.00	0.00	0.00	0.00	0.00	0.00	0.00
110	-4.25	-3.79	0.45	-2.79	1.46	-3.97	-3.25	0.72	-2.36	1.62		
120	-3.74	-3.96	-0.22	-2.23	1.51	-3.34	-3.30	0.04	-1.83	1.51		
130	-3.62	-3.79	-0.18	-1.90	1.72	-3.27	-3.14	0.13	-1.52	1.75		
140	-3.35	-3.18	0.17	-1.67	1.67	-2.96	-2.67	0.29	-1.36	1.60		
150	-2.83	-2.90	-0.07	-1.51	1.33	-2.41	-2.41	0.00	-1.26	1.15		
160	-2.69	-2.68	0.01	-1.40	1.29	-2.12	-2.25	-0.13	-1.15	0.97		
170	-2.33	-2.57	-0.24	-1.34	0.99	-1.92	-2.15	-0.22	-1.15	0.77		
180	-2.24	-2.34	-0.10	-1.17	1.07	-1.87	-1.94	-0.07	-0.94	0.93		
Mean difference (%)			-0.02		1.38			0.09		1.29		

Then, a pelvis IMRT plan was evaluated in an anthropomorphic phantom to observe the dosimetric impact of the couch presence or absence in the planning stage. For this, the best density values obtained in the previous experiment were used. According to the analysis shown in the dose

volume histogram (DVH) in Figure 8, with the presence of the BrainLAB™ couch, the prescription dose is present in 87% of the planned volume, and without the couch, in 97% of the volume. It means evaluating only the impact generated in the TPS, there is an underdosing of 10% when the presence of the couch in the TPS is not considered. The same pelvis planning was evaluated with the Exact™ couch in the thickest portion, and it was observed that the prescription dose enveloped 92% of the volume with the couch present, and 99% of the volume without it, with an underdosing of 7%.

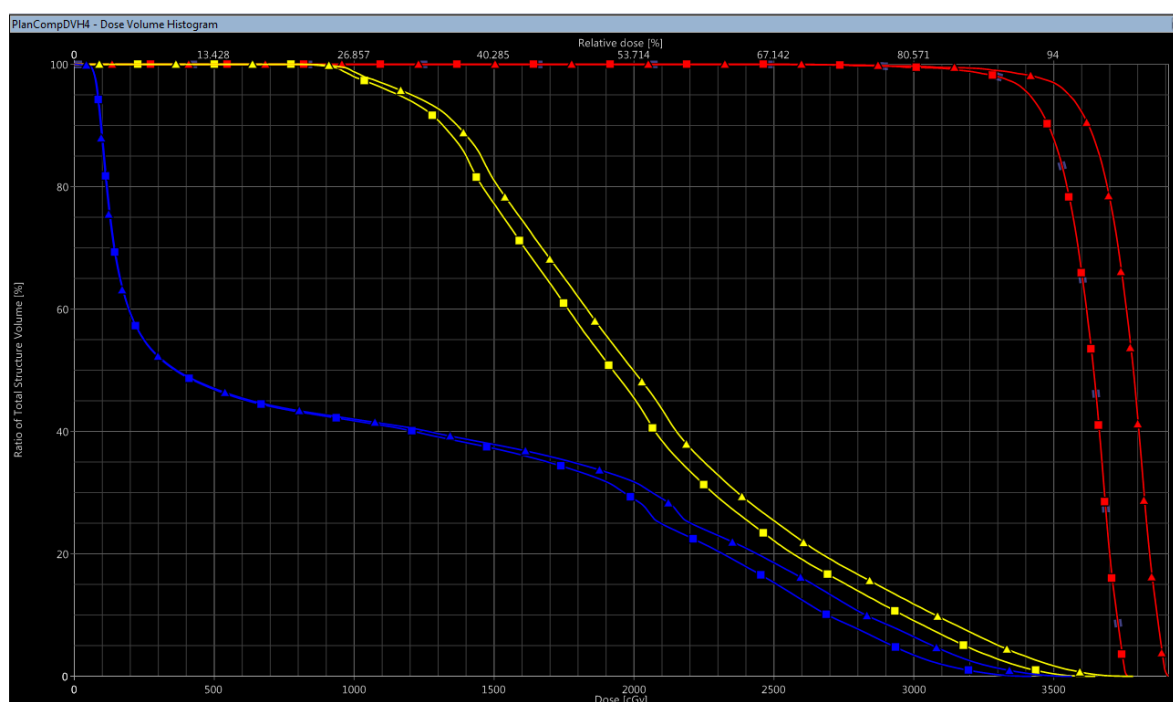

Figure 8: DVH of an IMRT planning with prescription dose of 3,500 cGy, 6 MV energy. Red line-squares represents volume coverage with the BrainLAB™ couch present and red line-triangles, without the couch. Yellow line refers to bladder dose and blue line refers to rectal dose.

4. DISCUSSION

The basis for this study was TG 176 [5] and there are series of percentage depth dose (PDP) tables for different energies and field sizes collected from different studies in it. For this present work, it was only possible to compare the results obtained for the energy of 6 MV, as it is the only energy in common between this study and TG 176. In TG 176, the build-up was obtained at a 1.2 cm depth for

the 20x20 cm² field, 1.3 cm for the 6x6 cm² field and for the other fields, 4x4 and 10x10 cm², 1.4 cm depth. In our experiments, the build-up on the BrainLABTM couch was obtained at a depth of 1.4 cm for most fields, except for the 20x20 cm² field, which was found at 1.3 cm. Our work has the same results for the 4x4, 6x6 and 10x10 cm² fields. For the ExactTM couch, the build-up was obtained at a depth of 1.6 cm for the 4x4 cm² field and for the other fields, at a depth of 1.5 cm. The observed variations are small and confirm the independence of the carbon fiber couch manufacturer for the PDP measurement with the gantry at 0°.

Seppälä and Kulmala performed surface dose measurements for several treatment couches at 6 and 15 MV energies, including BrainLABTM and ExactTM couches, for 10x10 and 20x20 cm² fields [17]. In this work, for the energy of 6 MV and BrainLABTM couch, the value found for surface dose for the 10x10 cm² field was 98.6% and for the 20x20 cm² field, 99.4%. While our work found a similar value for the two field sizes: 99.06% for the 10x10 cm² field and 99.18% for the 20x20 cm² field. For the ExactTM couch, Seppälä and Kulmala performed surface dose measurements only on the thinnest portion of this couch. At 6 MV of energy, 90.8% was observed for the 10x10 cm² field and 94.0% for the 20x20 cm² field. In our work, for the same energy, we observed the same value of 90.54% for the 10x10 cm² field and 93.14% for the 20x20 cm² field.

For the 15 MV energy, Seppälä and Kulmala study observed a surface dose of 69.6% for the 10x10 cm² field and 77.7% for the 20x20 cm² field, while we observed, under the same conditions, 72.33% for the 10x10 cm² field and 80.82% for the 20x20 cm² field. We noticed a similarity of values for the surface dose measurements between the two studies for the BrainLABTM and ExactTM couches, demonstrating the accuracy of the measurements performed at our institution.

For the ExactTM couch, the manufacturer's manual says that the head and neck accommodation region is equivalent to 5.2 mm of water, while the abdomen and pelvis accommodation region is equivalent to 8.4 mm of water, without describing for which energy these data were obtained [11]. Our results are close: for 6 MV energy, we found 7 mm of water equivalence in the thin portion and 8 mm in the thick portion. However, for the reading at the 15 MV energy, there is an equivalence of 1.5 mm of water in the thin portion and 2.3 mm of water in the thick portion. Our results suggest that the manufacturer's manual provides measurements only for 6 MV energy, despite not being properly specified.

About dose attenuation, there is a dose decrease for the different field sizes on all couches. It is expected that the greatest dose attenuation occurs in the angular intervals between 110° to 120° and 240° to 250° , since in these ranges the beam crosses greater distances inside the couch, as seen in Figure 4.

For the BrainLAB™ couch, Njeh *et al.* carried out a similar work, but with measurements made only with half arc (from 100° to 180°), with 6 MV energy [10]. The greatest attenuation occurred for the gantry at 120° in the 5×5 and 10×10 cm² fields, with an attenuation of 10.0% and 8.3%, respectively. Our work observed the highest attenuation for the same angle in both field sizes, with attenuations of 8.03% and 7.67%, respectively. Despite the dissimilarity of values, we also observed a trend of decreasing dose attenuation with the larger field sizes. Our results are closer to those observed for the same angle in the work by Serante *et al.* [15], with an attenuation of 8.15% for the 5×5 cm² field and 7.46% for the 10×10 cm² field. Similar work also observed close attenuations with the same couch and energy in different fields. Seppälä and Kulmala observed an attenuation of 8.7% for the 10×10 cm² field and 120° angle [17]. Differently, another study by Kim *et al.* observed the highest attenuation at 130° for the 5×5 cm² field, with a value of 6.82% [18].

For the Exact™ couch attenuation in the thinnest portion, Seppälä and Kulmala observed for the 10×10 cm² field, 6 MV energy, a maximum attenuation of 4.7%, and for the 15 MV energy, an attenuation of 3.1%, both for the 110° angle [17]. In our work, we also observed the highest attenuation in the thinnest portion at 110° , with a value of 4.51% at 6 MV energy and 2.95% at 15 MV energy, both for 10×10 cm² field. The results are similar between the two works, for the same conditions, demonstrating uniformity in the properties of this couch.

According to the information in the iBEAM™ couch manufacturer's manual, there is an attenuation of 2.4% at the 180° angle, 6 MV energy, field size 9.6×10.4 cm² [12]. Under the same conditions, we observed an attenuation of 2.43%. Smith *et al.* found an attenuation of 2.7% [19]. Zhang *et al.* measured the highest attenuation of 2.51% at 130° , for 6 MV energy and field size 10×10 cm² [20], while we observed the highest attenuation of 4.63% at 120° under the same conditions of energy and field size.

Another important point of this work is the evaluation of couch density values to be used in the TPS, so dose calculations correspond as close as possible to the experimental measurements. Other

works have the same objective, and each treatment center found the most befitting value according to their experiments.

For the BrainLABTM couch, 6 MV energy, Serante *et al.* observed that the best values to use in the TPS are 0.82 g/cm³ (HU = -200) for carbon fiber and 0.07 g/cm³ (HU = -900) for the foam [15]. Njeh *et al.* found that the best densities for carbon fiber and foam are, respectively, 0.55 g/cm³ and 0.03 g/cm³ [7]. Mihaylov *et al.* determined that the best density values for carbon fiber and foam are, in the same order, 0.7 g/cm³ and 0.1 g/cm³ [16]. We observed that the best values under these conditions are 1.2 g/cm³ (HU = 299) for carbon fiber and 0.1 g/cm³ (HU = -877) for the foam. The difference in values may be due to the setting used for the attenuation measurements. For example, we used a cylindrical phantom according to TG 176's orientation [5], as its geometry and thickness allows dose distribution under same conditions and depth, while Njeh *et al.* used solid water slabs [7]. Water slabs don't make a totally homogeneous phantom and it can lead to less accurate results such as maximum attenuation in incorrect position. Still on the matter of incorrect phantom model, interestingly, the first data generated for this work was obtained with a cylindrical phantom with several cavities. Due to non-homogenous nature of the phantom, our results were notably different than expected (discarded data), requiring new acquisitions.

For the thinner ExactTM couch, we found the best combination of densities for carbon fiber and foam are 0.82 g/cm³ (HU = -200) and 0.001 g/cm³ (HU = -1,000). While in the thickest portion, the best combination are 0.82 g/cm³ (HU = -200) and 0.03 g/cm³ (HU = -947), respectively. Wagner and Vorwerk report that the best values to be used in the TPS, for carbon fiber and foam, are, respectively, HU = -750 and HU = -995 [21]. However they do not inform values in g/cm³ and nor the couch region (thin or thick portion) that obtained these results in the TPS.

From our results, each treatment couch has an ideal density configuration and even if a couch has different thicknesses, it can have an optimized combination for its different parts. We observed that the field size and energy did not interfere in the density combination results, which suggests that there is no need to have a default for energy and field size, but the couch thickness factor must be taken in account.

Finally, we analyzed VMAT with full arch and IMRT with a great number of posterior fields planning, with and without the presence of treatment couches. In VMAT planning, with the ExactTM couch, there was no difference in dose coverage. It means that not considering the couch's presence

in the TPS planning had no impact on the dose delivered to the patient during treatment. The same cannot be said for IMRT planning. With a 3,500 cGy prescription dose, 6 MV energy, we observed that not including the BrainLAB™ couch can cause an underdosing of up to 10%, and the same occurred with the Exact™ couch, with an underdosing of 7%.

Pulliam *et al.* carried out extensive work to observe clinical differences between what the plan is believed to deliver as a dose to the patient and what is actually delivered for prostate cancer treatment cases, with or without the couch's presence [22]. They observed a 4.2% dose average loss delivered to the patient when not considering the couch's presence in the IMRT planning. In this work, they used the default HU for the Exact™ couch.

5. CONCLUSIONS

In this work, we present an extensive range of data on surface dose, dose attenuation and density values in the TPS that best result in dose distribution according to experimental measurements for BrainLAB™, Exact™ and iBEAM™ couches, for different field energies and sizes. When comparing these data with couches manufactures' manuals and similar published works, it is observed that there are differences for some conditions. Therefore, care must be taken in treatment planning with beams that cross the couch with posterior oblique angles. For TPS Eclipse™, the couch is in its library, but it is still necessary to insert it into the planning dose calculation for better accurate dose delivery to the patient. Since differences in couches' density components are observed in different works, it is recommended that each treatment center perform tests to determine the best density values for their respective TPS.

ACKNOWLEDGMENT

To the Health Ministry (SGTES) and the Ministry of Education (SESu) for the financial support during the residency period. To INRAD and ICESP, where this study was carried out. To Hospital

Sírio Libanês for providing the phantom for the experimental measurements. To Alexandre Giannecchini Romagnolo for his help structuring and providing textual cohesion.

REFERENCES

- [1] WHO. Cancer. Available at : <<https://www.who.int/en/news-room/fact-sheets/detail/cancer>> Last accessed: 11 Sep. 2021.
- [2] G. DELANEY, S. JACOB, C. FEATHERSTONE, AND M. BARTON. The role of radiotherapy in cancer treatment. **Cancer**, vol. 104, no. 6, pp. 1129–1137, Sep. 2005, doi: 10.1002/cncr.21324.
- [3] R. BASKAR AND K. ITAHANA. Radiation therapy and cancer control in developing countries: Can we save more lives? **International Journal of Medical Sciences**, vol. 14, no. 1, pp. 13–17, 2017, doi: 10.7150/ijms.17288.
- [4] T. P. HANNA, J. SHAFIQ, G. P. DELANEY, S. K. VINOD, S. R. THOMPSON, AND M. B. BARTON. The population benefit of evidence-based radiotherapy: 5-Year local control and overall survival benefits. **Radiotherapy and Oncology**, vol. 126, no. 2, pp. 191–197, Feb. 2018, doi: 10.1016/j.radonc.2017.11.004.
- [5] A. J. OLCH, L. GERIG, H. LI, I. MIHAYLOV, AND A. MORGAN. Dosimetric effects caused by couch tops and immobilization devices: Report of AAPM Task Group 176, **Medical Physics**, vol. 41, no. 6Part1, p. 061501, May 2014, doi: 10.1118/1.4876299.
- [6] L. G. DE MOOY. The use of carbon fibres in radiotherapy, **Radiotherapy and Oncology**, vol. 22, no. 2, pp. 140–142, Oct. 1991, doi: 10.1016/0167-8140(91)90010-E.
- [7] C. F. NJEH, J. PARKER, J. SPURGIN, AND E. RHOE. A validation of carbon fiber imaging couch top modeling in two radiation therapy treatment planning systems: Philips Pinnacle3 and BrainLAB iPlan RT Dose, **Radiation Oncology**, vol. 7, no. 1, p. 190, Dec. 2012, doi: 10.1186/1748-717X-7-190.
- [8] S. F. KRY, S. A. SMITH, R. WEATHERS, AND M. STOVALL. Skin dose during radiotherapy: a summary and general estimation technique, **Journal of Applied Clinical Medical Physics**, vol. 13, no. 3, pp. 20–34, May 2012, doi: 10.1120/jacmp.v13i3.3734.
- [9] C. F. NJEH, T. W. RAINES, AND M. W. SAUNDERS. Determination of the photon beam attenuation by the BrainLAB imaging couch: angular and field size dependence, **Journal of Applied Clinical Medical Physics**, vol. 10, no. 3, pp. 16–27, Jun. 2009, doi: 10.1120/jacmp.v10i3.2979.
- [10] VARIAN, **Specifications Exact IGRT Couch Precise Imaging**, vol. 1. United States, 2008.
- [11] ELEKTA, **iBEAM evo Couchtop User Manual**, vol. 1. Schwabmünchen, Germany, 2017.
- [12] P. ANDREO *et al.* **Absorbed Dose Determination in External Beam Radiotherapy: An International Code of Practice for Dosimetry based on Standards of Absorbed Dose to Water**, vol. 12. Vienna, Austria: INTERNATIONAL ATOMIC ENERGY AGENCY, 2006.
- [13] S. WELLHÖFER. **User's Guide to the SP34 QA Phantom**, vol. 1. Schwarzenbruck, Germany, 2003.

- [14] A. R. SERANTE, J. G. GONCALVES, W. F. P. NEVES-JUNIOR, J. P. S. LEITE, AND C. M. K. HADDAD. Attenuation measures of the BrainLAB imaging couch and validation on the treatment planning system Eclipse, **Revista Brasileira de Física Médica**, vol. 9, no. 3, pp. 28–33, 2015.
- [15] I. B. MIHAYLOV, P. CORRY, Y. YAN, V. RATANATHARATHORN, AND E. G. MOROS. Modeling of carbon fiber couch attenuation properties with a commercial treatment planning system, **Medical Physics**, vol. 35, no. 11, pp. 4982–4988, Oct. 2008, doi: 10.1118/1.2982135.
- [16] J. K. H. SEPPÄLÄ AND J. A. J. KULMALA. Increased beam attenuation and surface dose by different couch inserts of treatment tables used in megavoltage radiotherapy, **Journal of Applied Clinical Medical Physics**, vol. 12, no. 4, pp. 15–23, Sep. 2011, doi: 10.1120/jacmp.v12i4.3554.
- [17] T. H. KIM, S. A. OH, J. W. YEA, J. W. PARK, AND S. K. KIM. The Dose Attenuation according to the Gantry Angle and the Photon Energy Using the Standard Exact Couch and the 6D Robotic Couch, **Progress in Medical Physics**, vol. 27, no. 2, p. 79, 2016, doi: 10.14316/pmp.2016.27.2.79.
- [18] D. W. SMITH, D. CHRISTOPHIDES, C. DEAN, M. NAISBIT, J. MASON, AND A. MORGAN. Dosimetric characterization of the iBEAM evo carbon fiber couch for radiotherapy, **Medical Physics**, vol. 37, no. 7Part1, pp. 3595–3606, Jun. 2010, doi: 10.1118/1.3451114.
- [19] R. ZHANG, Y. GAO, AND W. BAI. Quantification and comparison the dosimetric impact of two treatment couch model in VMAT, **Journal of Applied Clinical Medical Physics**, vol. 19, no. 1, pp. 10–16, Jan. 2018, doi: 10.1002/acm2.12206.
- [20] D. WAGNER AND H. VORWERK, Treatment Couch Modeling in the Treatment Planning System Eclipse, **Journal of Cancer Science & Therapy**, vol. 03, no. 01, 2010, doi: 10.4172/1948-5956.1000049.
- [21] K. B. PULLIAM, R. M. HOWELL, D. FOLLOWILL, D. LUO, R. A. WHITE, AND S. F. KRY. The clinical impact of the couch top and rails on IMRT and arc therapy, **Physics in Medicine and Biology**, vol. 56, no. 23, pp. 7435–7447, Dec. 2011, doi: 10.1088/0031-9155/56/23/007.